

Vaisala HUMICAP® Hand-Held Humidity and Temperature Meter HM40 Series



HM41

HM42

HM45

HM46

PUBLISHED BY

Vaisala Oyj

Street address: Vanha Nurmijärventie 21
FI-01670 Vantaa, Finland

Mailing address: P.O. Box 26
FI-00421 Helsinki, Finland

Phone: +358 9 8949 1

Fax: +358 9 8949 2227

Visit our Internet pages at www.vaisala.com.

© Vaisala 2014

No part of this manual may be reproduced, published or publicly displayed in any form or by any means, electronic or mechanical (including photocopying), nor may its contents be modified, translated, adapted, sold or disclosed to a third party without prior written permission of the copyright holder. Translated manuals and translated portions of multilingual documents are based on the original English versions. In ambiguous cases, the English versions are applicable, not the translations.

The contents of this manual are subject to change without prior notice.

This manual does not create any legally binding obligations for Vaisala towards customers or end users. All legally binding obligations and agreements are included exclusively in the applicable supply contract or the General Conditions of Sale and General Conditions of Service of Vaisala.

Table of Contents

Table of Contents.....	1
First Startup.....	4
Initial Settings	4
Product Overview	5
HM41 - Front.....	7
HM41 - Back.....	8
HM42 for Tight Spaces	9
HM45 - Remote Probe with Handle	10
HM46 for Mechanically Demanding Applications	12
Batteries	13
Charging.....	14
Parameters Explained.....	15
Measurement Views	16
Screen Layout and Controls	16
Indicators	17
Numeric View.....	19
Statistics View	20
Graph View	21
Hold and Tag.....	23
Main Menu.....	25
Tagged Points.....	26
Graph Duration.....	27
Settings.....	28
Calibration	28
Help	29

Settings Submenu.....	30
Language.....	30
Units.....	31
Time & Date.....	31
Pressure.....	33
Reminder.....	34
Backlight.....	35
Battery.....	35
Power off.....	36
Navigation.....	36
Rounding.....	36
Factory Settings.....	37
How to Measure.....	38
Application Examples.....	40
Maintenance.....	44
Cleaning.....	44
Changing the Filter.....	45
Changing the Probe.....	46
Calibration.....	47
Calibrating the HM40 Using HMK15.....	48
Accessories and Parts.....	53
Filters.....	54
Chargers and Batteries.....	55
Belt Clips and Battery Covers.....	55
Technical Data.....	56
Relative Humidity and Temperature Measurement Performance.....	56
Mechanical.....	58

General.....	59
HM41 Dimensions	60
HM45 Dimensions	61
HM42 and HM46 Probe Dimensions	62

First Startup

1. Check that the probe is securely attached and remove the yellow transport protection cap from the probe.
2. Open the battery cover and insert two AA-size batteries.
3. Close the battery cover and turn on the meter by pressing the Power button. If the meter does not turn on, check the battery orientation. Replace the batteries with fresh/recharged ones if needed.

Initial Settings

When you power on the HM40 for the first time (or after a factory reset of the settings), you must first select the operation language. The meter will then ask if you want to change the following settings:

- Units
- Date
- Time

If you answer **Yes** to the question (recommended), the meter will show the settings screens before showing the measurement view. Use the arrow and function buttons to select. For more information, see section Settings Submenu on page 30.



HM40 will retain the date and time even during battery changes. The clock will have to be set again only if the meter is without battery power for several hours.

Product Overview

The Vaisala HUMICAP® Hand-Held Humidity and Temperature Meter HM40 Series comprises four models designed for various portable measurement applications. All models in the HM40 series use the HM40 hand-held indicator with one of four probe options:

- HM41 - Compact and portable standard option where a HMP113 probe attaches directly to the HM40 meter body.
- HM42 - HM40 meter with a spiral cable and handle connected to an Ø 4mm probe with a length of 235 mm. The structure of the probe is especially suitable for measurements in tight spaces, such as seams between wall tiles.
- HM45 - The HM45 uses the same HMP113 probe as HM41, but with a probe handle connected to the HM40 meter with a spiral cable, providing additional reach.
- HM46 - HM40 meter with a spiral cable and handle connected to a 320 mm robust stainless steel probe designed for mechanically demanding applications such as dirty processes and relatively high temperatures (temporarily up to 180 °C).

For more information on using the probes, see Application Examples on page 40.

For probe dimensions and technical data, see pages 56 and 60.

Main features of the HM40 series:

- Compact and robust housing.
- Measures a wide range of parameters: RH, Td, Tw, a, x, h, T. See section Parameters Explained on page 15.
- Large graphical display.
- Graphs for selected humidity parameter and temperature.
- Can be user calibrated (using the HMK15 humidity calibrator, for example).
- Powered by standard AA size batteries (2×).
- Indicator operation temperature range -10°C ... +60°C. Probe operation temperature ranges -40 °C ... +180°C, depending on probe model.
- Short (HM41/HM45) or long (HM42/HM46) soft case, depending on probe length.
- Belt clip.

Optional accessories:

- Different filters for increased protection against contaminants.
- USB-powered portable charger for AA-size NiMH rechargeables.



For more information and order codes of the accessories, see section Accessories and Parts on page 53.

HM41 - Front

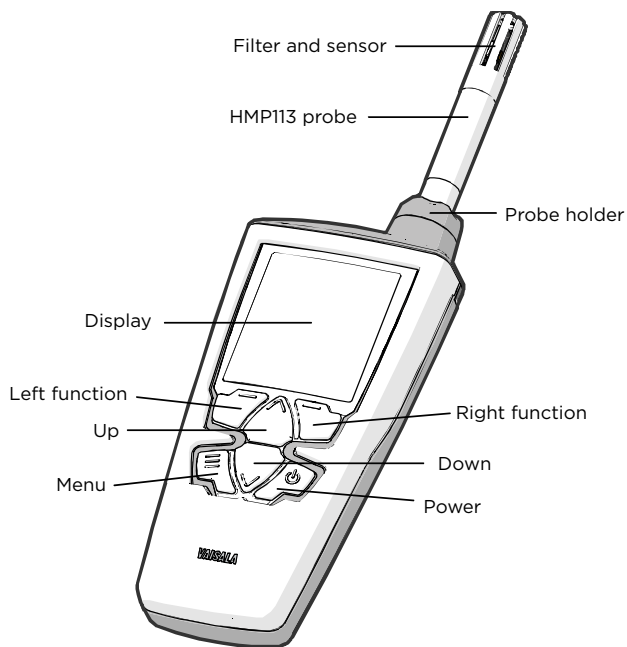

HM41 - Back

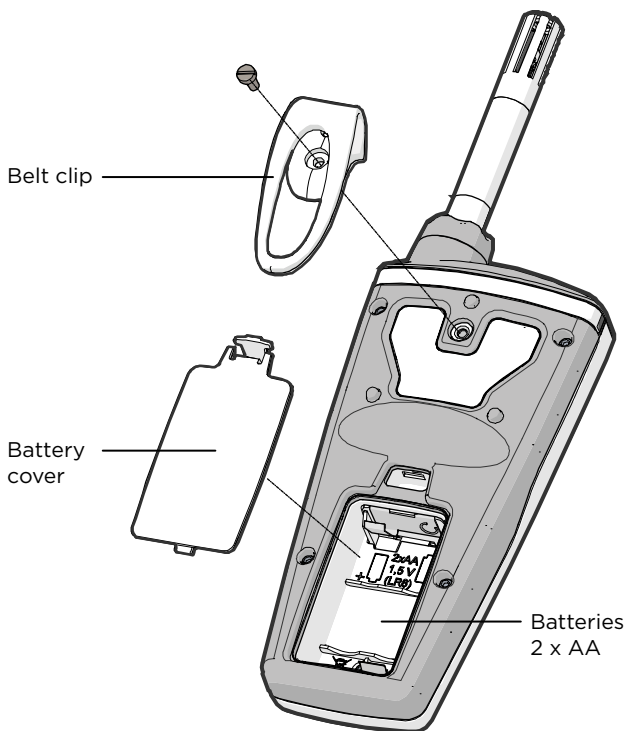

HM42 for Tight Spaces

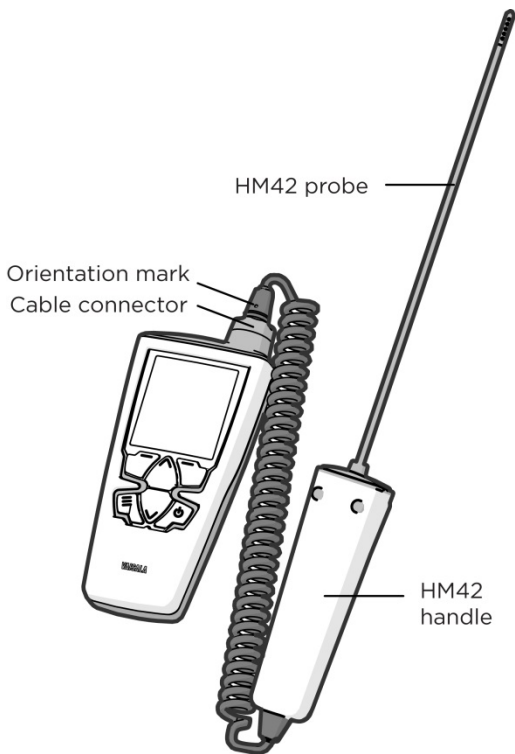

HM45 - Remote Probe with Handle

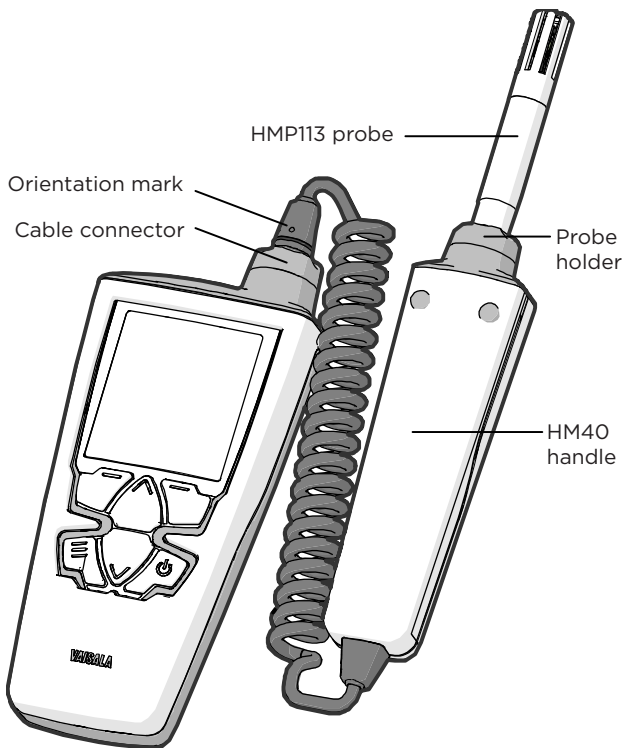

You can connect the HM45 handle to the belt clip for single handed use. Simply push the belt clip into the slot in the handle.

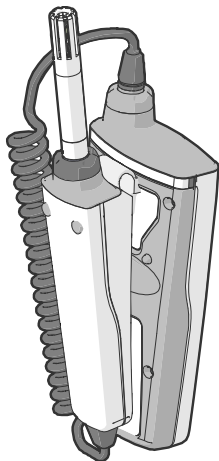

When the handle is connected to the meter in this way, you can lay down the meter on top of the handle.

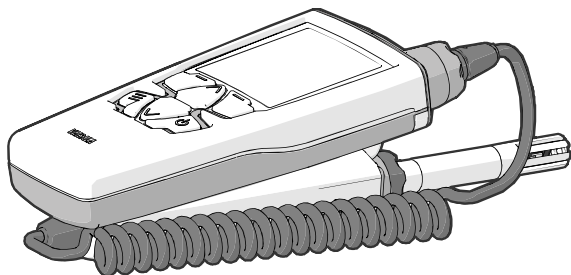

HM46 for Mechanically Demanding Applications

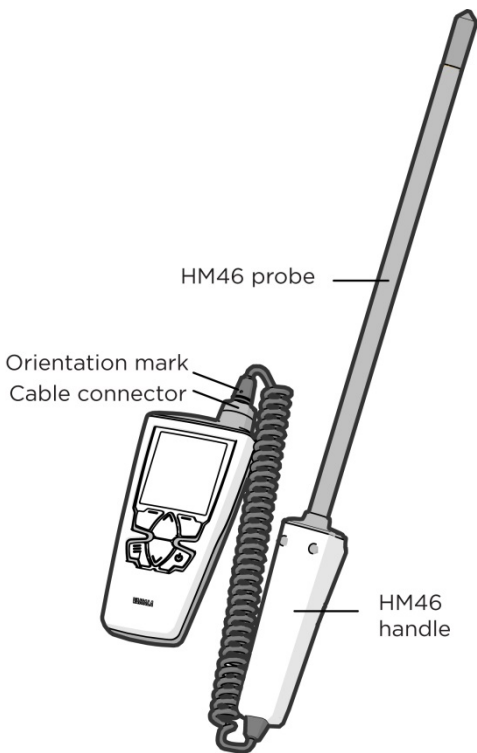

Batteries

The HM40 is powered by **two AA-size batteries**. You can use the following battery types:

- Alkaline (IEC-LR6)
- Lithium (IEC-FR6)
- NiMH (IEC-HR6)



Do not mix batteries of different types. Both batteries must be of the same type.



Observe the storage and operation instructions of the battery manufacturer.

Alkaline batteries are the standard choice in non-rechargeable batteries. They are a good match for the power requirements of the HM40.

Lithium batteries are a good choice if you need the longest battery life or best capacity in low temperatures. Lithium batteries are not rechargeable. Do not confuse them with lithium-ion batteries, which cannot be used in the HM40.

NiMH batteries are rechargeable, and available from Vaisala as an option. For order codes, see section Accessories and Parts on page 53. Instructions for using the optional USB charger are provided in section Charging on page 14.

Charging

The optional USB charger provides a convenient way to charge two NiMH batteries from any powered USB port (for example, from a laptop computer).

1. Place the rechargeable batteries in the charger and plug it into a USB port. The blue LED on top of the charger starts to blink.
2. When the LED stops blinking and stays on, the batteries are charged. The charging time is several hours for two fully discharged NiMH batteries.

If you are not using a Vaisala-supplied charger and rechargeable batteries, read and follow the manufacturer's own charging instructions.



Do not attempt to charge non-rechargeable (alkaline or lithium) batteries! Doing so leads to a risk of battery leakage, equipment damage, and risk of explosion and/or fire.

Parameters Explained

The table below describes the parameters measured by the HM40. All of the parameters are measured or calculated when the meter is on, independent of what is currently displayed. The parameters are also described in the indicator's Help menu (see page 29).

Parameter	Symbol	Unit(s)	Description
Relative humidity	RH	%	Ratio of the partial pressure of water vapor in the air to the saturation vapor pressure of air at the current temperature.
Dewpoint	Td	°C °F	Temperature at which the water vapor in the air will condense into water at the current pressure. When the dew point is below 0 °C, the meter outputs frost point instead of dew point.
Wet bulb temperature	Tw	°C °F	The minimum temperature that can be reached by evaporative cooling in the current conditions.
Absolute humidity	a	g/m^3 gr/ft^3	Quantity of water in a cubic meter (or cubic foot) of air.
Mixing ratio	x	g/kg gr/lb	Ratio of water vapor mass per kilogram (or pound) of dry air.
Enthalpy	h	kJ/kg btu/lb	Sum of the internal energy of a thermodynamic system.
Temperature	T	°C °F	Temperature in Celsius or Fahrenheit scale.

Measurement Views

Screen Layout and Controls

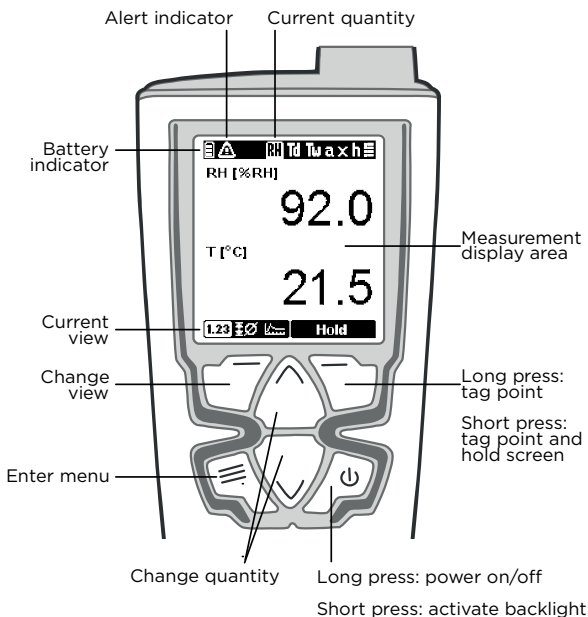

Pressing the right function button holds the screen and tags the current measurement point. See Hold and Tag on page 23.

Indicators



Battery charge indicator

Fresh batteries will always show three bars.

When the indicator shows two bars, the voltage of the batteries has started to drop. When there is a single (blinking) bar left, you should replace the batteries. The meter will turn off automatically when the battery voltage drops too low.



Alert indicator

This indicator is shown next to the battery charge indicator if there is a measurement problem. The most likely causes are low battery and probe problems, for example:

- Battery voltage too low to power the probe. The measured values may show asterisks "*" instead of numbers.
- Probe has been disconnected
- Probe has been damaged
- Probe is incompatible
- Probe is wet (probe recovers automatically when it dries). The measured values may show asterisks "*" instead of numbers.



Parameter indicator

The selected parameter is highlighted by a light frame. The symbol on the right stands for all parameters.

For the list of parameters, see section Parameters Explained on page 15.



Calibration reminder indicator

This indicator appears when you have set up a calibration reminder and the calibration is due. The indicator is shown until you calibrate the probe.

For instructions on setting up a calibration reminder, see section Reminder on page 34.

Numeric View

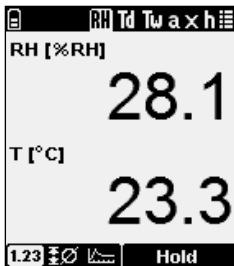

The **Numeric view** shows the current values of the selected humidity parameter and temperature.

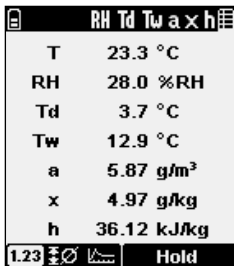

In the all parameters view, the font is smaller to fit all values on screen.

Statistics View

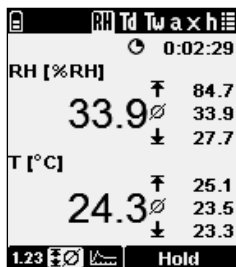

The **Statistics view** shows the current value of the selected parameter, as well as the maximum, average, and minimum value since the measurement was started. There is also a counter that shows how long the measurement has been running.

The icons are:

- Maximum
- Average
- Minimum
- Measurement time

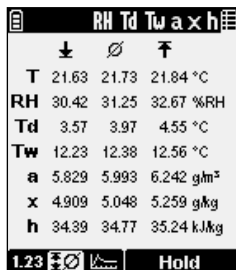

The counter for measurement time is not shown in the all parameters view.

Graph View

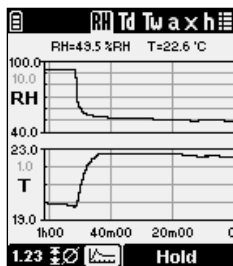

The **Graph view** shows a continuously updating graph of the selected parameter and temperature.

The graph limits and spacing adjust dynamically to show the full range of measurements.

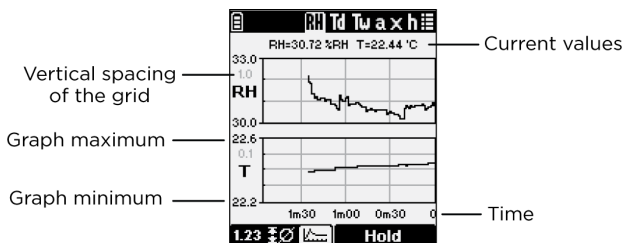

HM40 has no permanent memory for graph data: when the meter is turned off, the graphs are cleared. Only tagged points are stored in permanent memory. To avoid losing graph data while working, set a suitable delay for the automatic power off (see Power off on page 36) or disable it.

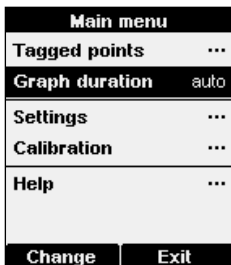

You can change the timescale of the graph in the **Main menu**.

By default, the graph will automatically change the timescale to fit the measured data. If you select a short timescale, only the most recent data will be visible.

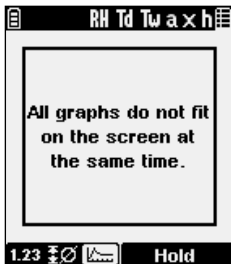

The graph view is not available in the all parameters view. Select a single parameter to show the graph.

Hold and Tag

If you press the right function button (**Hold** button) in a measurement view, two things happen:

- The measurement view freezes until you press the **Release** button.
- The latest measurement point is tagged (marked and stored in permanent memory). See section Tagged Points on page 26.

Tagged points are shown in the graph view as small dots below the graphs.

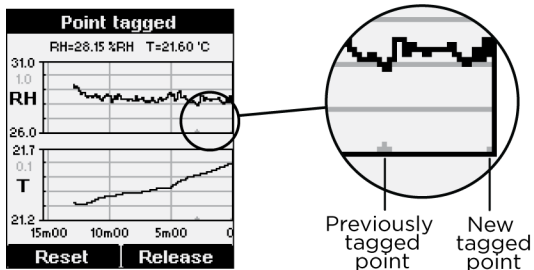

Tagged points		
Time	RH [%RH]	T [°C]
2:35:58	39.2	22.8
2:40:22	38.0	23.0
2:41:46	38.0	23.0

View Back

You can view the measurement values at the tagged points in the menu. You can also view and delete tagged points from memory in the menu options. See Tagged Points on page 26.

13.2.2014 11:30:47	
RH [%RH]	25.0
T [°C]	25.2

Reset Release

When the screen is held, the top of the display displays the current date and time. This is useful when you want to record the current data (take a photograph or write it down).

If time has not been set, the top of the screen will simply read "HOLD".



When the view is held, you can reset all measurement data by pressing the **Reset** button. This will clear all graphs and tagged points.



If you keep pressing the right function button (long press), the meter will tag the point without freezing the screen.

Main Menu

You can open the menu from the measurement view at any time by pressing the menu button.

If you are already in the menu, pressing the menu button returns you to the measurement view. If you are in a submenu, the menu button returns you to the previous menu level.

Main menu	
Tagged points	...
Graph duration	auto
Settings	
Calibration	...
Help	...
Enter	Exit

Use the arrow buttons to move up and down in the menu, and function buttons to operate the menu options. Typical functions in the menus are:

- **View** and **Enter** open the selected menu option or submenu.
- **Change** and **Set** change the value of the selected option.
- **Back** returns to the previous menu view.
- **Exit** closes the menu and returns to the measurement view.



Some menu screens have more content than can be visible at one time. This is indicated by a scroll bar that appears on the right side of the screen. Use the arrow buttons to scroll up and down.

Tagged Points

Main menu	
Tagged points	...
Graph duration	auto
Settings	...
Calibration	...
Help	...
View Exit	

Select **Tagged points** in the main menu to see the list of stored points and values.

Tagged points		
Time	RH [%RH]	T [°C]
2:36:58	39.2	22.8
2:40:22	38.0	23.0
2:41:46	38.0	23.0
View Back		

Time and temperature value are always shown for each tagged point. The humidity parameter that is shown is the same as you have selected in the measurement view. If all parameters view has been selected, RH is shown instead.

Point 3 / 3	
3.1.2014 2:41:46 (0:01:02 ago) G1030024	
T	23.0 °C
RH	38.0 %RH
Td	7.9 °C
Tw	14.4 °C
a	7.84 g/m ³
x	6.65 g/kg
h	40.18 kJ/kg
Delete	Back

The data stored for each tagged point includes:

- Time when the point was tagged.
- Serial number of the probe that was used (useful for identifying the point)
- Measured value of each parameter.

Press the **Delete** button to delete the point that is currently shown. To delete all points in memory, hold down the **Delete** button.



HM40 can store up to 40 tagged points. If a new tagged point is stored when the memory is full, the oldest tagged point is silently deleted to make room for the new point.

Graph Duration

Graph duration	
auto	X
1.5 min	
3 min	
7 min	
15 min	
30 min	
1 h	
Set	Back

In the **Graph duration** screen, you can select the timescale of the Graph view. The shortest selectable timescale is 1.5 minutes, the longest 32 hours.

You can also select **Autoscale**, which means that the timescale will automatically adjust to show all of the measurement data in memory, up to the maximum of 32 h.

Settings

Settings	
Language	English (en)
Units	...
Time & Date	...
Pressure	1013.3 hPa
Reminder	Every 3 mths
Backlight	Delay (30 s)
...	...
Choose	Back

Opens the **Settings** menu. The menu options are described in section Settings Submenu on page 30.

Calibration

Calibration	
How to Calibrate	
1 Quantity	RH [%RH]
2 Point count	1
3 Point 1	—
4 Point 2	—
5 Note	**VAISA...
6 Asses...	
Change	Back

In the **Calibration** submenu, you can perform an adjustment procedure that corrects the humidity and temperature measurement of the meter. For more information and the adjustment procedure, see section Calibration on page 47.

Help

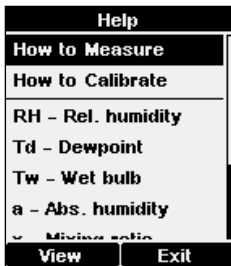

Opens a menu with help topics on measurement, calibration, and the measured parameters.

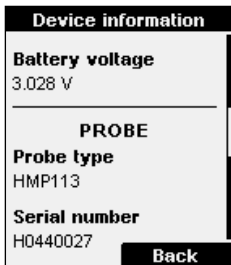

The help menu also includes a device information screen where you can view technical information about your indicator and probe.

Settings Submenu

Language



In the **Language** screen, you can change the display language of the meter. The choices are:

- English (en)
- German (de)
- French (fr)
- Finnish (fi)
- Spanish (es)
- Swedish (sv)
- Chinese (zh)
- Russian (ru)
- Japanese (jp)
- Portuguese (pt)

Units

Units	
Units	metric
Pressure unit	bar
Change	Back

The **Units** setting determines the measurement system that is used for the parameters: metric or non-metric.

- Metric
- Non-metric

The **Pressure unit** is set separately:

- hPa
- bar
- atm
- PSI

Time & Date

Time & Date	
Date	2014-06-19
Formatting	ISO
Time	6:47:45
Formatting	24 h
Set	Back

In the **Time & Date** menu, you can set the current date and time, and their presentation formats. Both date and time have their own pre-set formatting options.



In the **Date setup** screen, you can set the current date:

- **Arrow buttons** change the selected value
- **Left function** button selects the next value (year, month, or day).
- **OK** button stores the date and returns to the Settings menu.

After setting the date, set the desired date format using the **Formatting** option in the Time & Date menu.



In the **Time setup** screen, you can set the current time:

- **Arrow buttons** change the selected value.
- **Left function** button selects the next value (hours, minutes, or seconds).
- **OK** button stores the time and returns to the Settings menu.

After setting the time, select 24h or 12h clock using the **Formatting** option in the Time & Date menu.

Pressure



In the **Pressure setup** screen, you can set the current ambient pressure. The pressure information is used when calculating certain humidity parameters, such as mixing ratio (symbol x).

If the ambient pressure differs significantly from the default setting of 1.0132 bar (due to high altitude, for example), set the correct pressure value so that the HM40 meter can calculate the measurement correctly.

Reminder

Settings	
Language	English (en)
Units	...
Time & Date	...
Pressure	1013.3 hPa
Reminder	6 months
Backlight	Delay (30 s)
...	...
Change	Back

Use the **Reminder** option to set a reminder for calibrating the probe. You can choose a preferred calibration interval of 3, 6, 12, or 24 months. Calibrating the probe resets the calibration interval. To remove the reminder from use, select **Disabled**.

Note that you must set the correct date in the indicator for the calibration reminder to appear as intended.

Calibration reminder	
Probe calibration has expired. Last calibration was completed 14 months ago. Vaisala Service Centers provide calibration and repair services. Check shipping instructions for www.vaisala.com	
Snooze	Close

The calibration reminder appears one month before the preferred calibration date is due.

To continue displaying the reminder for this interval, select **Snooze**. The reminder will appear again at each power-on.

To hide the reminder, select **Close**. If you do not calibrate within a month, the reminder will appear again.



Calibrating any parameter in the probe resets the calibration interval. This means that if you leave one parameter uncalibrated in a calibration session, the reminder will not appear separately for that parameter.

Backlight

Settings	
Units	...
Time & Date	...
Pressure	1013.3 hPa
Reminder	Every 3 mths
Backlight	Delay (30 s)
Battery	Alkaline
Maximum Time	Manual
Change	
Back	

Always on: Screen is always lit. This option will shorten the battery life significantly.

Always off: Screen is always unlit. This option provides the best battery life.

Delay (30s): Backlight will automatically turn on when the user presses any button. The backlight will turn off after 30 seconds of inactivity.

Dimmed: Screen is always lit with a dim backlight.

Battery

Use the **Battery** setting to tell the meter what kind of batteries are installed. This will help to scale the battery indicator correctly. The options are:

- Alkaline
- Rechargeable

Power off

The **Power off** setting defines how long the device can remain inactive before powering off automatically. The time limit options are 10, 30, and 60 minutes. Select **Never** to disable automatic power off.



HM40 has no permanent memory for graph data: when the meter is turned off, the graphs are cleared. Only tagged points are stored in permanent memory. To avoid losing graph data while working, set a suitable delay for the automatic power off or disable it.

Navigation

Navigation setting affects the behavior of arrow buttons in the measurement view:

- **Normal:** Up arrow moves parameter selector left, down arrow moves it right
- **Inverted:** Reverses the direction

Rounding

Rounding setting affects the number of decimal places that are used to show the measurements:

- **On:** Measured values are rounded to **one** decimal place.
- **Off:** Measured values are shown with **two** decimal places.

Factory Settings

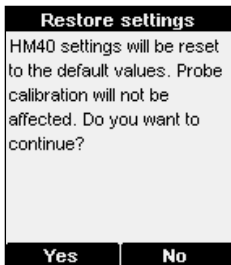

The **Factory settings** option restores all settings to their default values. Probe calibration is not affected.

How to Measure

Remove the Transport Protection Cap

Remove the yellow transport protection cap from the probe when taking the meter into use.

Measure in a Stable Environment

If the measurement conditions are changing, you cannot get a reliable measurement result. Do not measure near heat sources, air conditioning, open doors, or windows.



For best results, leave the meter on in the measurement area and come back to check it later.

Avoid Temperature Differences

Temperature differences are a typical cause of error in humidity measurement and calibration. You must let the meter stabilize long enough: temperature differences level out very slowly.

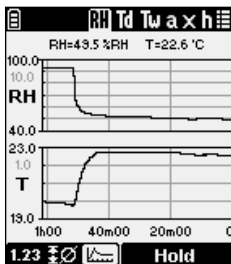

Switch to the Graph view and wait until the graphs level out, indicating that the measurement is now stable.

Avoid Condensation and Rain

If the humidity sensor element becomes wet, the meter cannot measure until the sensor is dry again. Avoid rain and conditions where condensation can form on the sensor.

Do not replace the transport protection cap if the probe or the cap is wet, since it will prevent the probe from drying.



Do not touch the sensor or blow on it to dry it out.

Calibrate the Meter Regularly

It is recommended that you calibrate the probe **once a year**, or if you have any reason to believe it is no longer within its accuracy specification. See section Calibration on page 47.

You can set a reminder for calibration at preferred calibration intervals (3, 6, 12 or 24 months). See section Reminder on page 34.

Application Examples

HM41

HM41 uses a fixed HMP113 probe, providing a compact solution that is ideal for spot checks in open spaces.

The optional membrane filter for the HMP113 probe increases protection against contaminants.

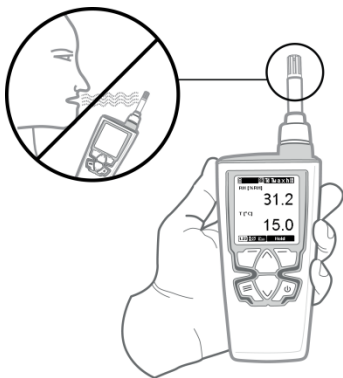

When measuring with HM41, always hold the meter at a sufficient distance to avoid affecting the results with moisture from your breath.

HM45

HM45 uses the same HMP113 probe as HM41. In HM45, the probe is attached to a handle that is connected to the HM40 indicator with a spiral cable, providing additional reach.

HM42

HM42 has a small, Ø 4 mm probe head with a length of 235 mm. The thin structure of the probe makes it suitable for measurements in tight places such as joint spaces between tiles and beneath flooring.

Typical applications include mapping the affected area in water damage restoration, measuring moisture in insulation materials, and measuring the equilibrium humidity of, for example, timber.

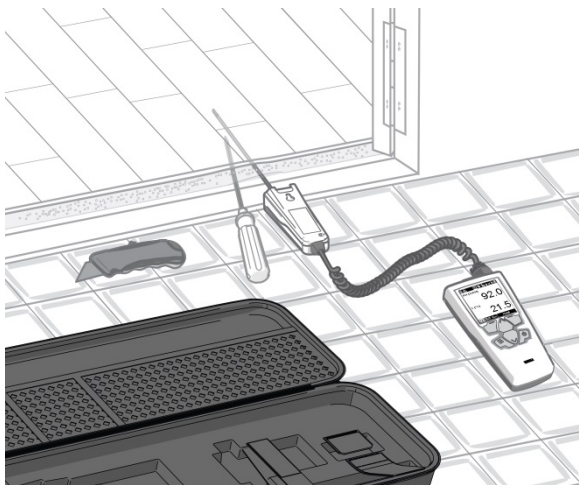

Use a suitable tool such as a screw driver to create a space for the probe before inserting it.

To avoid bending or damaging the probe, never force it through structures.

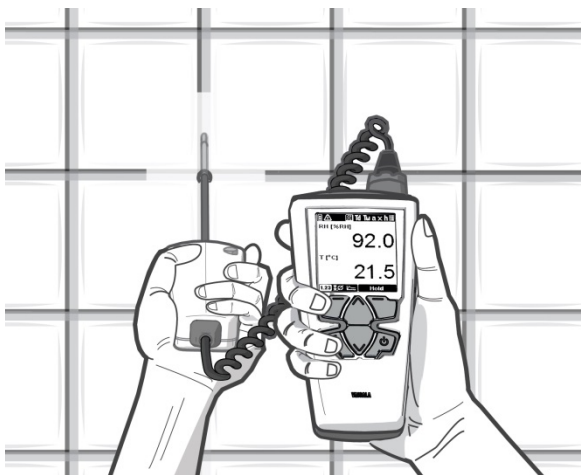

When measuring, for example, from a wall so that the probe is placed in a horizontal position, make sure the probe does not bend: do not leave the probe unsupported.

Always insert the probe at least 4 cm inside the structure from which you are taking measurements.

Never leave the meter and the handle hanging down freely from the probe.

HM46

HM46 uses a 32 cm stainless steel probe that is optimized for mechanically demanding applications that require a robust probe structure, for example measurements in relatively high temperatures (up to +100 °C, temporarily even +180 °C) or in dirty processes.

In addition to water damage mapping applications, common uses for the HM46 include plant maintenance and the installation and inspection of air conditioning systems, production and storage areas, and production processes.

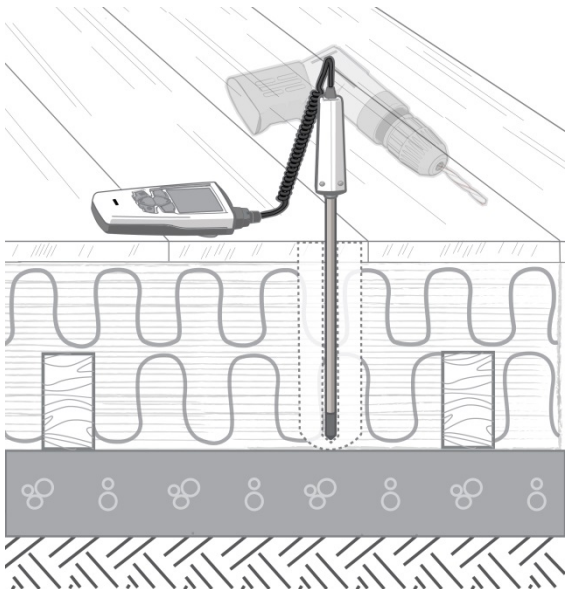

Maintenance

Cleaning

The HM40 can be cleaned by wiping it with a moist cloth.

If the filter becomes contaminated, it is very likely to affect the humidity measurement since residue on the filter will retain some moisture. Dirty filters should be replaced.

Do not use solvents to clean the HM40. Do not spray anything directly on the HM40, since that may deposit impurities on the sensor.



Do not immerse the HM40 in liquid to clean it.



Do not attempt to clean the sensor element that is located inside the filter. Any touching (or blowing with pressurized air) may damage it. If the measurement accuracy cannot be restored by calibration and adjustment, it is time to replace the probe.

Changing the Filter

For information on filter options, see Filters on page 54.

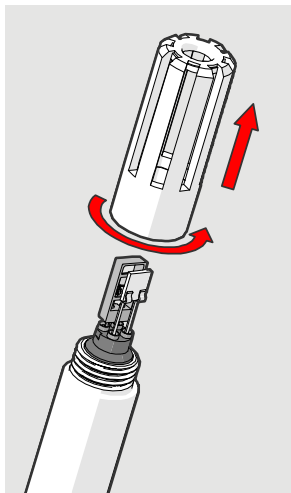

1. Turn the filter counter-clockwise to open it.
2. Turn the filter until it can be removed.
3. Pull the filter out straight. Do not touch the sensors with the filter.
4. Install the new filter and tighten it.

Changing the Probe

Changing the probe is tool-free and is done in the same way for the HM41 probe attached to the meter body and when using one of the probes with a handle.

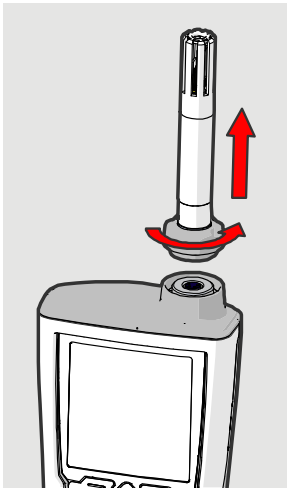

1. Press the power button to turn off the meter.
2. Turn the probe holder (the grey nut at the base of the probe) counter-clockwise to loosen the probe.
3. Pull the probe holder and probe together away from the connector.
4. If the new probe does not have a probe holder, remove it from the old probe by pulling it over the filter and place it on the new probe.
5. Push the pins of the new probe in the holes of the connector. Tighten the probe holder.
6. Press the power button to turn on the meter.



If the alert indicator comes on after starting the meter, check the connection and verify that the probe has been ordered as a spare part for the HM40.

Calibration

The humidity measurement accuracy of the probe should be checked **once a year**. You can do this yourself using a humidity reference (for example, the Vaisala Humidity Calibrator HMK15), or send the probe to a Vaisala Service Center for calibration

For instructions on setting a calibration reminder message (3-24 month interval), see Reminder on page 34.

If the calibration shows that the measurement accuracy is no longer within specification, the probe must be adjusted. If accuracy cannot be restored with adjustment, the probe must be replaced. All probes that are ordered from Vaisala are delivered calibrated. See section Accessories and Parts on page 53.



If you think the meter is not measuring humidity or temperature correctly, calibration and adjustment is not the first thing to do. Try the following first:

- Make sure nothing is interfering with the measurement: heat sources, temperature differences, or condensation.
- Check that there is no moisture on the probe. If the sensor has become wet, you must allow it to dry before you can measure.
- Always wait for the measurement to stabilize.



For an introduction to calibration, order or download the free calibration book:

www.vaisala.com/calibrationbook

Calibrating the HM40 Using HMK15

The HMK15 Humidity calibrator allows you to produce known humidity environments using saturated salt solutions.



Performing a good calibration takes some time and preparation. Read the HMK15 User's Guide before performing your first calibration with the HMK15.

Main menu	
Tagged points	...
Graph duration	auto
Settings	...
Calibration	...
Help	...
Enter	Exit

1. Press the Menu button and select the **Calibration** submenu.

Calibration	
How to Calibrate	
1 Quantity	RH [%RH]
2 Point count	1
3 Point 1	—
4 Point 2	—
5 Note	**VAISA...
6 Apply	
Change	Back

2. Select the parameter to be calibrated at menu item **[1] Quantity**. You can calibrate Temperature (T) or Relative Humidity (RH) measurement. All other humidity parameters are calculated from RH and T, so they will also be adjusted.

Calibration	
How to Calibrate	
1	Quantity RH [%RH]
2	Point count 2
3	Point 1 —
4	Point 2 —
5	Note **VAISA...
6	Amplitude
Change	Back

3. Select the number of calibration points at menu item **[2] Points**. You can perform a 1-point or 2-point calibration.

For a 2-point calibration, you need two reference environments. For example, LiCl and NaCl salt chambers provide 11% and 75% relative humidity references.

Note that when performing a 2-point RH calibration, the first point requires a < 50% RH humidity reference, and the second point must be > 50% RH.

The difference between the two references must be at least 30% RH.

4. Remove the filter from the probe and place the probe in the first reference environment (first calibration point). Take care not to damage the sensors. Wait 20 - 40 minutes for the reading to stabilize.

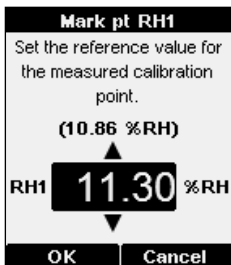

5. Select menu item **[3] Point 1** and press the Set button. The meter now shows the currently measured value of the selected parameter. Set the reference value using the arrow buttons and press the OK button.

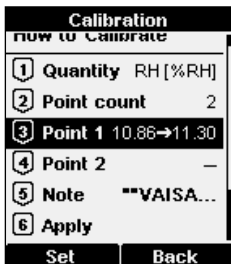

The correction to the measurement at point 1 is now shown in the text for menu item [3]. If you are only doing a 1-point calibration, skip to step 8.

6. Place the probe in the second reference environment (second calibration point). Wait 20 - 40 minutes for the reading to stabilize.

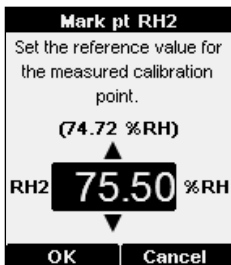

7. Select menu item **[4] Point 2** and press the **Set** button. The meter now shows the currently measured value of the selected parameter. Set the reference value using the arrow buttons and press the **OK** button.

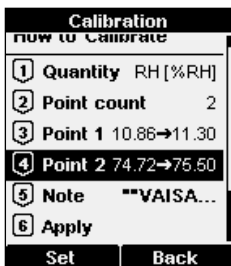

The correction to the measurement at point 2 is now shown in the text for the menu item [4].



8. Select menu item **[5] Note** to edit the calibration info text that is stored in the probe. Edit the text using the select button and arrow keys. When done, select the **OK** character in the bottom right corner to save the changed text.

To exit without saving, press the **Cancel** button.

Confirmation	
Type	RH (2 points) [%RH]
RH1	10.86→11.30
RH2	74.72→75.50
Difference	64.20 %RH
Apply	Cancel

9. Select menu item **[6] Apply** to save the calibration in the probe. Check the applied corrections in the confirmation screen and press the Apply button.

To exit without applying the correction, press the **Cancel** button.

Accessories and Parts

	Order code
HM40 indicator, no probe	HM40INDI
Belt clip (3 pcs)	227710SP
Battery cover (3 pcs)	225688SP
NiMH rechargeable batteries (4 pcs)	229247SP
External battery recharger with USB connection and 2 batteries	229249SP
Case for short HM40 probes	235849SP
Case for long HM40 probes	DRW242351SP
HM41 & HM45 probes	
HMP113 probe for HM40	HMP113 (conf. V00B2C1A0)
Plastic nut for HMP113 attachment	DRW238590SP
Plastic grid filter for HMP113 probe	DRW236214SP
Plastic grid with membrane filter for HMP113 probe	230727SP
HM40 handle and cable (HM45 only)	HM40HANDLE
HM42 probe	
Probe for HM42, diameter 4 mm	HM42PROBE
Steel grid filter for sensor protection	19867HM
Membrane tube set (5 pcs) for filter	19858HM
Rubber sleeve set (10 pcs)	19809HM
Calibration adapter for HM42PROBE	HM37067
HM46 probe	
Probe for HM46, diameter 12 mm	HM46PROBE
Sintered filter	0195
Membrane filter, up to 80 °C	10159HM
Plastic grid filter, up to 80 °C	6221
Disposable sleeve (50 pcs)	1558
Probe holder	HM36915



When ordering an HMP113 probe for HM41 and HM45, use the HMP113 configuration code V00B2C1A0 to get the compatible probe.

Filters

HM41 & HM45 (HMP113 probe)

Plastic grid filter The standard choice. It provides the fastest response time, as air can flow freely around the sensors.

Plastic grid with membrane filter Has a membrane under the plastic grid (0.2 μm pore size) for additional protection against contaminants. It slows down the response time of the probe.

HM42

Steel grid filter with membrane tube The standard choice. The membrane should be changed periodically and when it is getting dirty.

HM46

Sintered filter The standard choice. It has the same temperature tolerance as the probe itself.

Plastic grid filter Provides a faster response time than the sintered filter but it has a more limited temperature tolerance. This filter is only recommended for non-demanding applications.

Membrane filter Provides a faster response time than the sintered filter but it has a more limited temperature tolerance. The membrane under the plastic grid provides additional protection against contaminants compared to using only the plastic grid filter.



For instructions on replacing a filter, see section Changing the Filter on page 45.

Chargers and Batteries

You can order an external battery recharger with USB connection and compatible NiMH rechargeable batteries from Vaisala. For more information, see the following sections of this manual:

- Batteries on page 13
- Charging on page 14

Belt Clips and Battery Covers

If you need a new belt clip or battery compartment cover, you can order replacements from Vaisala.

Technical Data

Relative Humidity and Temperature Measurement Performance

Relative Humidity

Measurement range	0 ... 100 %RH
Accuracy (including non-linearity, hysteresis, and repeatability)	
HM41	
at 0 ... +40 °C	±1.5 %RH (0 ... 90 %RH) ±2.5 %RH (90 ... 100 %RH)
at -10 ... 0 °C and +40 ... +60 °C	±3.0 %RH (0 ... 90 %RH) ±4.0 %RH (90 ... 100 %RH)
HM42	
at 0 ... +40 °C	±1.5 %RH (0 ... 90 %RH) ±2.5 %RH (90 ... 100 %RH)
at -40 ... -0 °C and +40 ... +80 °C	±3.0 %RH (0 ... 90 %RH) ±4.0 %RH (90 ... 100 %RH)
at +80 ... +100 °C	±4.0 %RH*
	^{*)} Not recommended for $T_d > 85$ °C.
HM45	
at 0 ... +40 °C	±1.5 %RH (0 ... 90 %RH) ±2.5 %RH (90 ... 100 %RH)
at -40 ... 0 °C and +40 ... +60 °C	±3.0 %RH (0 ... 90 %RH) ±4.0 %RH (90 ... 100 %RH)
HM46	
at 0 ... +40 °C	±1.5 %RH (0 ... 90 %RH) ±2.5 %RH (90 ... 100 %RH)
at -40 ... -0 °C and +40 ... +80 °C	±3.0 %RH (0 ... 90 %RH) ±4.0 %RH (90 ... 100 %RH)
at +80 ... +100 °C	±4.0 %RH*
	^{*)} Not recommended for $T_d > 85$ °C.
Factory calibration uncertainty at +20 °C (+68 °F)	±1.5 %RH

Humidity measurement response time	
HM41, HM45 (90%) with plastic grid filter	17 s
HM42 (90 %) with membrane filter and steel grid	26 s
HM46 (90 %) with brass sintered filter	40 s
Stability	±2 %RH over 2 years
Humidity sensor	
HM41, HM45, HM46	HUMICAP® 180R
HM42	HUMICAP® 100R-Mini

Temperature

Measurement range	
HM41	-10 ... +60 °C (+14 ...+140 °F)
HM42	-40 ... +100 °C (-40 ... +212 °F)
HM45	-40 ... +60 °C (-40 ... +140 °F)
HM46	-40 ... +100 °C (-40 ... +212 °F), short-term up to +180 °C (+356 °F)
Accuracy over temperature range	
at 0 ... +40 °C (+32 ... +104°F)	±0.2 °C (0.36 °F)
at -40 ... 0 °C and +40 ... +100 °C (-40 ... +32 °F and +104 ... +212 °F)	±0.4 °C (0.72 °F)
Temperature Sensor	
HM41, HM45, HM46	Pt1000 RTD Class F0.1 IEC 60751
HM42	Pt1000 RTD Class F0.3 IEC 60751

Mechanical

Weight (with alkaline batteries)

HM41	230 g
HM42	370 g
HM45	330 g
HM46	490 g

Materials

Meter body	PC/ABS blend, acrylic display lens
Probe holder	PC/ABS blend (grey)
Probe handle	PC/ABS blend (white), PC/ABS blend (gray, HM45) or PBT (gray, HM42/46)
HMP113 probe or probe measurement head	PC/ABS blend (white, HM41/45), or stainless steel (HM42/46)
Filter	
HM41, HM45	PC (glass reinforced)
HM42	Stainless steel, PTFE membrane
HM46	Sintered brass
Housing classification	IP54
HM42 and HM46 probes	IP40

General

Power-up time	<3 s
Batteries	2 × AA sized, 1.5 V
Calculated parameters	Td, Tw, a, x, h
Menu languages	English, Chinese (simplified), Finnish, French, German, Japanese, Portuguese, Russian, Spanish, Swedish
Display	LCD (140 x 160 pixels)
Operation time (typical)	typical 100 hours (without backlight)
Operation temperature range	
Indicator	-10 ... +60 °C (+14 ... +140 °F)
Probe handle	-40 ... +60 °C (-40 ... +140 °F)
Probe head	<i>(see specifications for each probe type, ranges -40 ... +180 °C (-40 ... 356 °F))</i>
Storage temperature range	-30 ... +70 °C (-22 ... +158 °F)
Electromagnetic compatibility (EMC)	EU directive EN61326-1 for portable equipment

HM41 Dimensions

The dimensions are given in millimeters (mm).

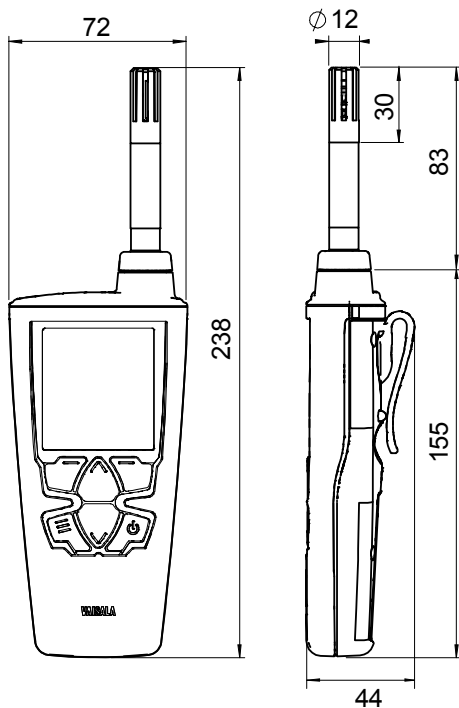

HM45 Dimensions

The dimensions are given in millimeters (mm).

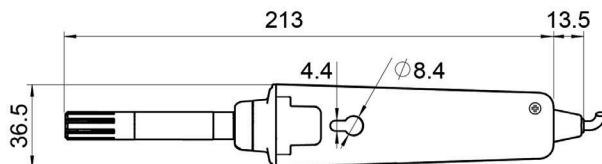
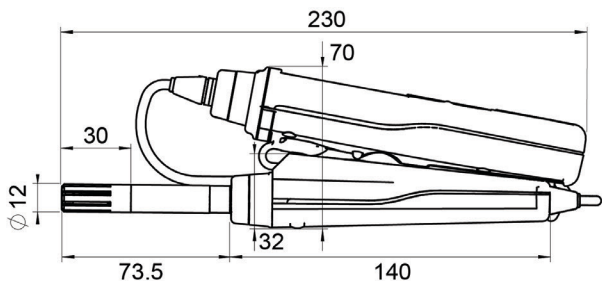

HM45: 1200

HM42 / HM46: 1500

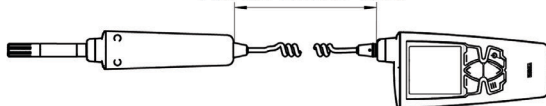

HM42 and HM46 Probe Dimensions

The dimensions are given in millimeters (mm).

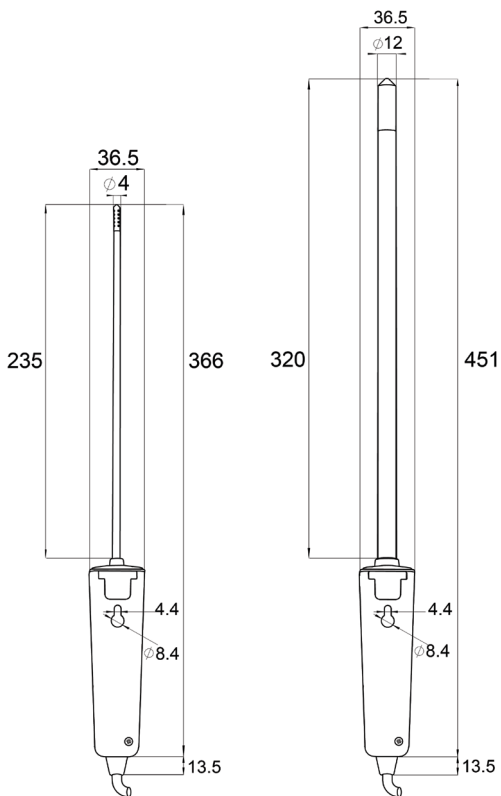



Download manuals at:
www.vaisala.com/manuals



Technical support by e-mail:
helpdesk@vaisala.com

Warranty information:
www.vaisala.com/warranty

Vaisala Service Centers:
www.vaisala.com/servicecenters



Purchase instruments and
spare parts online at
store.vaisala.com

 Álava Ingenieros
GRUPO ALAVA

tel: +34 915 679 700
www.alavaingenieros.com | alava@grupoalava.com



VAISALA